

OPERATOR'S MANUAL

32mm Narrow Crown Stapler

C9032V



IMPORTANT

Please make certain that the person who is to use this equipment carefully reads and understands these instructions before starting operations.

FIG. A



FIG. B - CONNECTING A TOOL TO THE AIR SUPPLY

STAPLER	QUICK CONNECTOR	OILER	FILTER	AIR SUPPLY
TACKER	SCHNELLVERBINDER	ÖLER	FILTER	LUFTZUFUHR
AGRAFEUSE	RACCORD RAPIDO	GRAISSEUR	FILTRE	ALIMENTATION EN AIR
GRAPADORA	CONECTOR RÁPIDO	LUBRICADOR	FILTRO	SUMINISTRO DE AIRE
CUCITRICE	CONNETTORE RAPIDO	LUBRIFICATORE	FILTRO	ALIMENTAZIONE ARIA

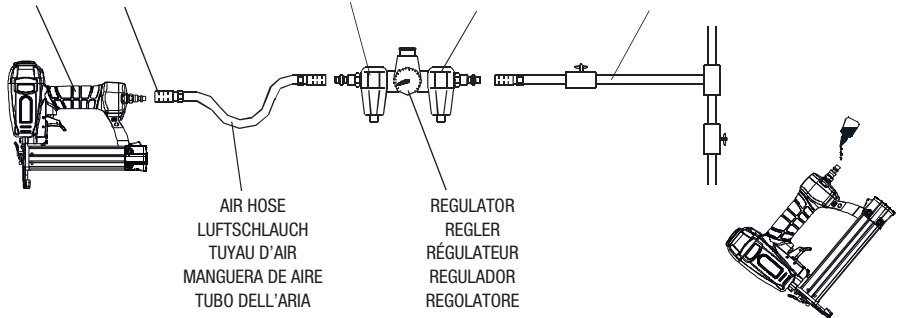

FIG. C - LOADING THE FASTENERS

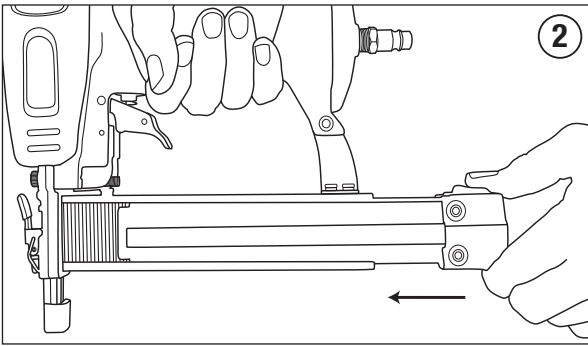
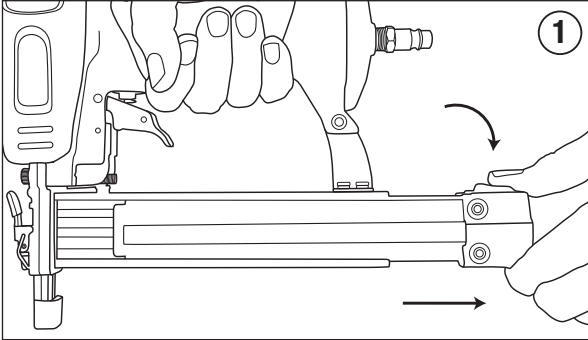

FIG. D - ADJUSTING THE DEPTH

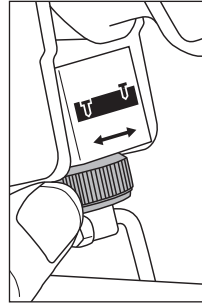

FIG. E - AIR DEFLECTOR

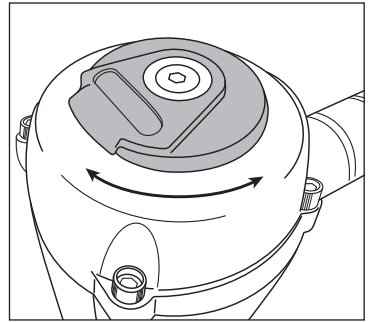

FIG. F - SAFETY BRACKET

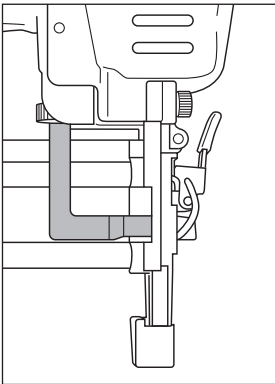
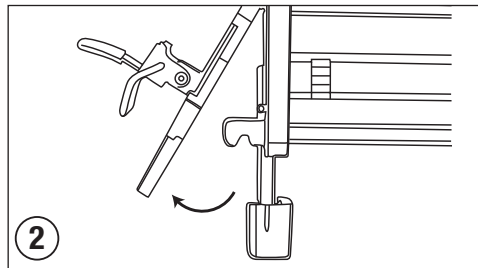
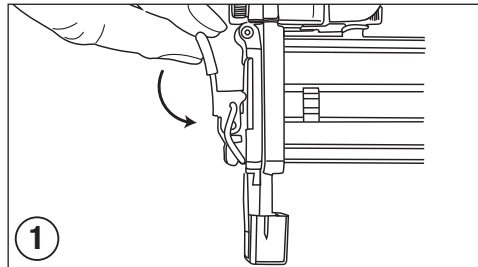

FIG. G - REMOVING A JAMMED FASTENER



EN 32mm Narrow Crown Stapler C9032V**Congratulations!**

On the purchase of your Tacwise power tool. Your tool will perform to your satisfaction for a long time if handled in accordance with our Safety and Operating instructions.

Save this manual for future reference**Technical Data**

Characteristic	Value
Minimum operating air pressure	60psi
Maximum operating air pressure	100psi
Staple length range	10mm (3/8") - 32mm (1 1/4")
Staple size	90
Magazine capacity	100
Air inlet	1/4" NPT
Air consumption	0.8 CFM @ 90psi
Weight	1.2kgs (2.6lbs)
Vibration emission level*	1.9m/s ²

* The declared vibration emission level represents the main applications of the tool. However if the tool is used for different applications, with different accessories or poorly maintained, the vibration emission may differ. This may significantly increase exposure level over the total working period.

**CE – Declaration of Conformity
32mm Narrow Crown Stapler C9032V** 

Tacwise declares that this power tool has been designed in compliance with the Regulations and Standards of the European Directives.

Quality Department, Tacwise Group Plc – UK

WARNING! Before Use Carefully Read And Understand All Instructions.

Failure to do so could result in fire and/or serious personal injury. For any queries relating to safety matters on this power tool, please email service@tacwise.com.

Unpacking

- Carefully remove the tool and accessories from the box.
- Inspect the tool carefully to make sure no breakage or damage occurred during transit.
- If any parts are damaged or missing, please email service@tacwise.com for assistance. Do not operate this tool until the missing or damaged parts are replaced. Failure to do so could result in a personal injury.
- Whilst every effort has been made to ensure accuracy of information contained within this manual, the Tacwise policy is one of continuous improvement to our products and as such we reserve the right to change the product specification without prior notice.

General Safety Instructions

Important. Tacwise recommends that this power tool should not be modified or used for any application other than that for which it was designed. Any such alteration or modification is misuse and could result in a hazardous condition leading to a personal injury. If you are unsure of its relative applications do not hesitate to contact us and we will advise you.

Work Area

- **Keep your work area clean and well lit.** Cluttered benches and dark areas invite accidents.
- **Keep children and pets away.** All visitors should be kept a safe distance from work area.
- **Secure work.** Use clamps or a vice to hold work. This frees both hands to operate the power tool.

Safety Warnings & Cautions

- **Never use oxygen combustible gases, bottled gases or high pressure compressed gas as a power source for this tool.** The tool may explode and cause serious injury.
- **Outdoor extension cords.** When air compressor is used outdoors, use only rounded jacket extension cords intended for outside use. See manufacturer's manual for the AWG required for the compressor's amperage draw.
- **Pay attention to air hose and their connections.** Don't trip over hoses. Make sure all connections are tight.
- **Use the correct air connector.** The connector on the tool must not hold pressure when the air supply is disconnected. If the wrong fitting is used, the tool can be charged with air after being disconnected and still be able to drive a fastener.
- **When connecting the air.** The tool may possibly fire the fasteners as soon as you plug it in to the air hose. Therefore, remove all the fasteners before connecting to the air.
- **Do not depress the trigger when loading.**
- **If the fasteners are jammed.** Disconnect the tool from the air and remove the jammed fasteners.
- **Stay alert.** Always watch what you are doing and use common sense. Do not operate a power tool when you are tired or under the influence of medication, alcohol or drugs.
- **Wear proper clothing.** Do not wear loose clothing or jewellery that can catch in moving parts. Non-slip footwear is recommended. Contain long hair and roll long sleeves above the elbow.
- **Do not over reach or use on unstable surfaces.** Keep proper footing and balance at all times.
- **Use safety equipment.** Dust mask, non-skid safety shoes, hard hat, or hearing protection must be used for appropriate conditions. Wear CE approved safety goggles at all times. Normal spectacles only have impact resistant lenses; they are NOT safety glasses.
- **DO NOT use on hard surfaces** such as rock, concrete, masonry, bricks or steel. Personal injury or damage to the power tool could result.
- **Stored power tools.** When not in use, all power tools should be stored in a dry, locked cupboard, out of the reach of children and other untrained persons.
- **Recommended accessories.** Use only accessories that are recommended by the manufacturer for your model. Accessories that may be suitable for one tool may create a risk of injury when used on another tool.
- **Beware of hidden danger.** Always make sure there is no danger of hitting any hidden power cables, water or gas pipes.
- **Always assume that the tool is loaded with fasteners.** Handling the tool without care could result in an unexpected firing of fasteners and lead to personal injury.
- **Do not activate the power tool unless it is in contact with the work piece.** Serious injury can result if you depress the safety lock pin on nose/contact trip with your fingers, or by improper operation.

- **Never point any power tool at yourself or at any other person.** While working, hold the tool in such a way that no injuries can be caused to the head or to the body in the event of possible recoil.
- **Do not drive fasteners on top of other fasteners.**
- **Do not use this tool to fasten electric cables.** This tool is not designed for the installation of electric cabling and may damage electric cables which could lead to injury by electric shock or fire hazards.

Features (Fig. A)

1. Trigger
2. Quick Release Plug (Euro Fitting)
3. Magazine Release Switch
4. Magazine
5. Depth Adjustment Wheel
6. Non-Marking Nose
7. Quick Release Nose Gate
8. Safety Bracket
9. Air Deflector

Set up

Your air tool is fully assembled when you receive it. Before using it, attach the air line and desired air system accessories. See Fig. B for the recommended accessories and connection order. Be sure the air hose is de-pressurised when installing or removing adaptors to the air line.

Connecting The Tool to an Air Supply (Fig. B)

- Determine if the tool needs oil and, if necessary, place two drops of oil in the air plug as shown in Fig. B. If you are using an automatic in-line oiler, check and add oil if necessary.
- Turn the compressor on and set the regulator to the proper pressure for the size and type of fastener being used.
- Connect the tool to the air supply.

Loading the Tool with Staples/Nails (Fig. C)

- Depress switch at rear of magazine and pull moveable part out (1).
- Place a strip of fasteners along channel, positioning fasteners at the bottom of the open magazine channel (2).
- Slide the magazine shut until the magazine release switch clicks.

Adjusting the Depth (Fig. D)

The driving depth of the fasteners can be set with the depth adjustment wheel (5).

- **Fasteners are not driven in deep enough:** To increase the driving depth, turn depth adjustment wheel to the left.
or
- **Fasteners are driven in too deeply:** To reduce the driving depth, turn the depth adjustment wheel to the right.
- Test the new driving depth on a test workpiece. Repeat steps above as required.

Operating the Tool

Test the driving depth in a sample piece of wood before using. See section ADJUSTING THE DEPTH.

- Connect the tool to the air supply. Make sure the air pressure is in correct range denoted in section of TECHNICAL DATA.
- Load fasteners as directed in the section called LOADING THE FASTENERS.
- Hold the body and press the drive guide to work surface, be sure the tool is straight and then gently depress the trigger to drive the fastener.
- Lift the tool off the work surface.

Firing Mode

Contact trip (Bump fire):

- First, depress the TRIGGER, then, repeatedly impact the SAFETY BRACKET (Fig. F), the tool can repeatedly drive the fasteners. The tool will drive one fastener when the safety bracket is impacted once.

NOTE: The air deflector (Fig. E) is directional and can be rotated through 360°.

Removing a Jammed Fastener (Fig. G)

NOTE: You must remove any jammed fasteners before using the tool any further. If you continue to try and fire a fastener while the tool is jammed, you could cause damage to the mechanism.

- Disconnect tool from the compressed air system
- Remove any unused fasteners from the magazine channel, this should clear the jammed fastener(s).
- Remove any jammed fasteners from the nose piece by opening the quick release nose gate.
- Release the latch on the nose gate (1) and open up the nose plate. Any jammed fastener(s) will be visible and can be removed.
- Close the nose plate and lock the latch before reconnecting to the air system.

CAUTION: Never release the nose gate if there are fasteners in the magazine channel. This could cause the fasteners to fire out of the front of the tool and could lead to serious injury.

- Following the removal of a jammed fastener, always carefully test the tool function before proceeding with any work. If fasteners become jammed in the nose piece frequently, have the tool serviced by a Tacwise Engineer or appointed service agent.

Regular Maintenance

- Frequent, but not excessive, lubrication is required for best performance. Oil added through the airline connection will lubricate internal parts. An automatic airline oiler is recommended but oil may be added manually before every operation or after about 1 hour of continuous use. Only a few drops of oil at a time are necessary. Too much oil will collect inside the tool and be blown out during the exhaust cycle. **ONLY USE PNEUMATIC TOOL OIL.** Do not use detergent oil or additives, as these lubricants will cause accelerated wear to the seal in the tool.
- Use a small amount of oil on all moving surface and pivots.
- Dirt and water in the air supply are major causes of pneumatic tool wear. Use a filter/oiler for better performance and longer life. The filter must have adequate flow capacity for the specific application. Consult the manufacturer's instructions for proper maintenance of your filter.
- Keep tools clean for better and safer performance. Use non-flammable cleaning solutions (**CAUTION:** Such solutions may damage O-ring and other tool parts) only if necessary - **DO NOT SOAK.**

Troubleshooting

Stop using the tool immediately if any of the following problems occur. Serious personal injury could occur. Any repairs or replacements must be completed by a qualified person or an authorised service centre only.

PROBLEM	CAUSE OF PROBLEM	SOLUTION
Air leaking at trigger area	<ol style="list-style-type: none"> 1. O-ring in trigger valve is damaged. 2. Trigger valve head is damaged. 3. Trigger valve stem, seal or O-ring is damaged. 	<ol style="list-style-type: none"> 1. Check and replace O-ring. 2. Check and replace trigger valve head. 3. Check and replace trigger valve stem, seal or O-ring.
Air leaking between body and front plate	Damaged piston O-ring or bumper	Check and replace O-ring or bumper
Air leaking between body and cylinder cap	<ol style="list-style-type: none"> 1. Screw loose. 2. Damaged seal. 	<ol style="list-style-type: none"> 1. Tighten screws. 2. Check and replace seal.
Blade driving fastener too deeply	<ol style="list-style-type: none"> 1. Worn bumper. 2. Air pressure is too high. 	<ol style="list-style-type: none"> 1. Replace bumper. 2. Adjust the air pressure.
Runs slowly or has power loss	<ol style="list-style-type: none"> 1. Insufficient oil. 2. Insufficient air supply. 3. Broken spring in cylinder cap. 4. Exhaust port in cylinder cap is blocked. 	<ol style="list-style-type: none"> 1. Lubricate as instructed. 2. Check air supply. 3. Replace spring. 4. Replace damaged internal parts.
Tool skips a fastener	<ol style="list-style-type: none"> 1. Worn bumper or damaged spring (53). 2. Dirt in front plate. 3. Inadequate airflow to tool. 4. Worn or dry O-ring on piston. 5. Damaged O-ring on trigger valve. 6. Cylinder cap seal leaking. 	<ol style="list-style-type: none"> 1. Replace bumper or pusher spring. 2. Clean drive channel of front plate. 3. Check hose and compressor fittings. 4. Replace O-ring or lubricate. 5. Replace O-ring. 6. Replace seal.
Fasteners are jammed	<ol style="list-style-type: none"> 1. Joint guider is worn. 2. Fasteners are wrong size or damaged. 3. Magazine or front plate screws are loose. 4. Blade in piston assembly is damaged. 	<ol style="list-style-type: none"> 1. Replace joint guider. 2. Use the recommended and undamaged fasteners. 3. Tighten screws. 4. Replace piston assembly.
Tool will not drive down tight	<ol style="list-style-type: none"> 1. Worn blade in piston assembly. 2. Lack of power. 3. Slow cycling and loss of power. 	<ol style="list-style-type: none"> 1. Replace piston assembly. 2. Adjust to adequate air pressure. 3. Check cylinder cap spring for broken coils or reduced length. Check if exhaust port of cylinder cap is restricted.

